



Impro EC^{II}

Impro (EC^{II}) Ethernet Controller INSTALLATION MANUAL

SPECIFICATIONS

Working Environment

Aluminium Extruded Cabinet (XEC900)	Designed to work in an indoor (dry) environment similar to IP30. The Controller is, therefore, not sealed against water.
Power Supply Combo..... (IPS970)	Designed to work in an indoor (dry) environment similar to IP20. The Power Supply Combo is, therefore, not sealed against water.

Power

Aluminium Extruded Cabinet (XEC900)

Input Voltage	10 V DC to 30 V DC.	
Power Requirements	Current (mA)	Power (W)
Supply Voltage 10 V DC (Maximum).....	420	4.2
Supply Voltage 30 V DC (Maximum).....	140	4.2

System Battery

Battery Type.....	6 V 3 Ahr Sealed Lead Acid Battery.
Battery Life.....	4-6 Hours uninterrupted operation. 48 Hours Power Shutdown, Hibernation Mode.

Power Supply Combo (IPS970)

NOTE: The Power Supply Combo includes a 3 A Switch Mode Power Supply which provides power for the (optional) internal unit and for charging the (optional) backup Battery. As the Power Supply Combo needs no more than 1 A, you may power extra devices using up to 2 A continuous current from the provided connector block. DO NOT exceed this 2 A limit on continuous current draw.

Devices with a high in-rush current demand, such as certain maglocks and other electromechanical devices, can momentarily draw more than 3 A. The Power Supply then effectively shuts down as directed by its built in protection as exceeding the 3 A rating is considered a short-circuit. Overcome this by installing the recommended 12 V 7 Ahr Battery to help supplement the in-rush current such a device may draw on activation.

Power Input

Input Voltage 85 V AC to 265 V AC at 50/60 Hz.

Power Output

Output Voltage (Mains Power On) 13.8 V DC ±0.3 V DC.

Output Current 2 A continuous (Power Output Terminals).

System Battery

Type 6 V 3 Ahr (Max) Sealed Lead Acid Battery.
 Approximate Length 151 mm (6 in) (Max).
 Approximate Width 65 mm (3 in) (Max).
 Approximate Height 99 mm (4 in) (Max) including the terminals.

The following specifications are common to both the Aluminium Extruded Cabinet and the Power Supply Combo:

Real Time Clock (RTC) Backup Battery

Battery Type 1 x 3 V, CR2032, Lithium cell Battery.
 Battery Life 2 Years with power OFF,
 5 years with power ON,
 5 years storage with Battery Tab in place.

Controller Communication

Ethernet Port

Connection Standard Ethernet RJ45 connector.
 10/100/1 000 Mbps, half or full duplex.

NOTE: The Impro ECII is rated to 100 MBps, however the Controller will work on a 1 000 MBps (1 GB) network.

Protocol TCP/IP, UDP.

NOTE: The RS485 1 (Controller) Port connection details only apply to Impro EC^{II} Controllers with Firmware V7.16 upwards.

RS485 1 (Controller) Port

Configuration 38 400 Default.
 Electrical Interface RS485.
 Baud Rates 9 600, 19 200, 28 800, 38 400 and 57 600
 selectable via the Communications Protocol.

RS485 1 (Controller) Port (Continued)

Data Format	8 data bits, no parity, 1 stop bit.
Communications Protocol	Impro Secure Communications Protocol.
Line Termination	Provision is made for line termination.
Default Mode.....	Receive Mode.

Terminal Communication

RS485 2 (Terminal) Port

Configuration.....	38 400 Default.
Electrical Interface	RS485.
Baud Rates	9 600, 19 200, 28 800, 38 400, 57 600 and 76 800 selectable via the Protocol.
Data Format	8 data bits, no parity, 1 stop bit.
Communications Protocol	Impro Secure Communications Protocol.
Line Termination	Provision is made for line termination.
Default Mode.....	Receive Mode.

General

Memory

RAM (Non-volatile).....	64 MBytes.
Flash ROM.....	8 MBytes.

Diagnostic LED Indicators

Power-on LED.....	Red LED (internally visible).
Incoming RS485 1 (Controller)	Flashing Green LED (internally visible).
Outgoing RS485 1 (Controller)	Flashing Red LED (internally visible).
Incoming RS485 2 (Terminal)..	Flashing Green LED (internally visible).
Outgoing RS485 2 (Terminal)..	Flashing Red LED (internally visible).
Link Speed LED (Ethernet)	Flashing Red LED (internally visible).
Duplex Mode LED (Ethernet) .	Flashing Red LED (internally visible).
Link Active LED (Ethernet).....	Flashing Red LED (internally visible).
CPU Usage	Red LED (internally visible). On = Idle, Off = Busy.
CPU Running	Red LED (internally visible). On = Yes, Off = No.
CPU Fault	Red LED (internally visible). On = Fault Condition, Off = Ok.

Blank Space

INSTALLATION INFORMATION

Accessories

Find the following when unpacking the Impro EC^{II} Controller:

- Either, an Impro EC^{II} Controller (XEC900) housed in a Black, powder-coated, Aluminium extruded Cabinet. The Cabinet consists of a Top Cover and a Base sealed at each end with a Mild Steel End Plate, secured with 5 Thread Cutter Screws (M3 x 8 mm).
- Or, an Impro EC^{II} Controller (IPS970) housed in a Black Mild Steel, powder-coated Cabinet. The Cabinet consists of a hinged Lid and a Base.
- A 3 V, CR2032, Lithium cell Battery.
- A 6 V 3 Ahr Sealed Lead Acid Backup Battery.
- Four Combi Screws (No. 4 x 10 mm) (IPS970 Only).
- A glass Fuse, Slow Blow, 3.15 A, 250 V (5 mm x 20 mm) (IPS970 Only).
- A MAC Address Label.
- An extra Fixed Address Label.

General

Remember the following when installing your Impro EC^{II} Controller:

Communications Distance

RS485 1 (Controller Port) and RS485 2 (Terminal Port)

The RS485 communications distance between the Impro EC^{II} Controller and the LAST Impro Unit in a cable run, MUST NOT exceed 1 km (1 090 yd). Achieve this by using good quality screened twisted pair Mylar cable, EARTHED on one side.

Ethernet Port

The Ethernet Controller plugs into an Ethernet Switch or Hub (or other network device), cable runs for this must conform to Ethernet cabling specifications.

Termination Resistors for RS485 Bus Communications

Long transmission lines or multiple “star” connections, may cause communication problems. Placing the Terminating Resistor Jumper Link in the LAST UNIT AT THE END OF THE CABLE RUN should solve the problem (depending on the bus). Refer to Figure 1 on page 8.

EARTH Connection

In conditions where excessive noise is present connect the Impro EC^{II} Controller to a good EARTH point. Using either of the RS485 Ports, connect the EARTH Lead to the “SHD” Terminal. Mains EARTH can be used, but electrical noise may persist. The EARTH Lead to the Impro EC^{II} Controller should have a minimum cross-sectional area of 1 mm² (0.001 in²) and can be either solid or stranded.

Blank Space

Installing the Real Time Clock (RTC) Backup Battery

CAUTION: Remove the Battery Tab for the Real Time Clock from the Battery Holder BEFORE powering up the Impro EC^{II}.

Refer to Figure 1 for the location of the Real Time Clock Backup Battery Holder.

First Time Use

1. Access the Impro EC^{II} Controller's Printed Circuit Board (PCB):
 - For XEC900, remove the Controller's Top Cover.
 - For IPS970, open the Lid of the Cabinet.
2. Locate the removable Battery Tab in the Real Time Clock Battery Holder (See Figure 1 and Figure 2 for location).
3. Pull the removable Battery Tab out of the Battery Holder.
4. Complete installation by:
 - For XEC900, replace the Controller's Top Cover.
 - For IPS970, close the Lid of the Cabinet.

Replacement

1. Access the Impro EC^{II} Controller's Printed Circuit Board (PCB):
 - For XEC900, remove the Controller's Top Cover.
 - For IPS970, open the Lid of the Cabinet.
2. Remove the old 3 V, CR2032, Lithium cell Battery from the Battery Holder by pulling the plastic retaining clip AWAY from the Battery Holder. The Battery Holder is spring-loaded and will raise the Battery out of the Holder.
3. Slide the NEW 3 V, CR2032, Lithium cell Battery under the metal clip of the Battery Holder, with the "+" Terminal facing UP.
4. Pull the plastic clip away from the Battery Holder and press the Battery firmly into the Battery Holder.
5. Complete replacement by:
 - For XEC900, replace the Controller's Top Cover.
 - For IPS970, close the Lid of the Cabinet.

Installing the 6 V 3 Ahr Sealed Lead Acid System Backup Battery

First Time Use

Aluminium Extruded Cabinet (XEC900)

1. Open the Controller's Top Cover.
2. Attach the Battery Fly Lead to the System Backup Battery Connector (see Figure 1 for Key Component Positions).
3. Attach the Controller's Top Cover.

Power Supply Combo (IPS970)

1. Open the Lid of the Cabinet.
2. Slide the Lid in an upwards direction and unHINGE.

3. Place the Battery into the Cabinet with the Battery Terminals in an upwards position.
4. Connect the Red Battery Terminal Lead to the Positive Battery Terminal.
5. Connect the Black Battery Terminal Lead to the Negative Battery Terminal.
6. Re-hinge the Lid and slide it in a downwards direction.
7. Close the Lid of the Cabinet.

Replacement

Aluminium Extruded Cabinet (XEC900)

1. Remove the Controller's Top Cover.
2. Remove the Controller's back End Plate.
3. Disconnect the Battery Fly Lead Spade Terminals from the old Battery.
4. Slide the old Battery out of the Battery Compartment.

CAUTION: Ensure that you maintain the correct polarity of the Battery Fly Lead Spade Terminals. Red wire to Positive (+) and Black wire to Negative (-).

5. Slide the new Battery into the Battery Compartment.
6. Reconnect the Battery Fly Lead Spade Terminals to the new Battery.
7. Attach the Controller's back End Plate.
8. Attach the Controller's Top Cover.

Database Backup (Battery Low)

On Battery Low, when the Controller reaches the end of its 48 Hour Hibernation Mode, the Battery reaches a point where it cannot maintain the Database in the Controller's memory. To reduce the risk of losing the Controller's Database, we recommend that you backup the Database to a USB Flash Disk as follows:

NOTE: *Acceptable Flash Disk sizes include 128 MB, 256 MB, 512 MB or 1 GB (maximum usable size).*

1. Format the Flash Disk in **FAT32**.
2. If already powered up, power down the Controller.
3. Plug the USB Flash Disk into the USB Host Port on your Controller.
4. Apply power thereby restarting the Controller.

NOTE: *Ensure that the USB Flash Disk remains plugged into the USB Host Port on the Controller for this feature to function correctly.*

Mounting the Controller

CAUTION: Make certain that you mount the Controller on a vibration-free surface.

Select the mounting position of the Impro EC^{II} Controller, considering accessibility and routing of wires. Secure the Controller to the mounting surface, using four suitable screws and wall plugs, nuts and bolts or rivets.

Mounting the Power Supply Combo (IPS970)

NOTE: *During mounting, we recommend removing the Power Supply Combo's Earth Strap. As indicated in Figure 2, locate and disconnect the Earth Strap from the Lid of the Cabinet. This allows easy removal and replacement of the Lid during installation. After installation, we strongly recommend you reattach the Earth Strap to the Lid.*

Use the supplied Connection Leads for the low voltage connections to the Power Supply Combo. Using the supplied Quick Click Glands or Gland Breakouts, neatly lead the wires out of the Cabinet.

1. Fix the Base to the wall using two suitable screws in the Mounting Key Holes.
2. Fix the third screw in the Mounting Slot, adjusting the position of the Base if necessary.

Blank Space

ELECTRICAL CONNECTIONS

Key Component Positions

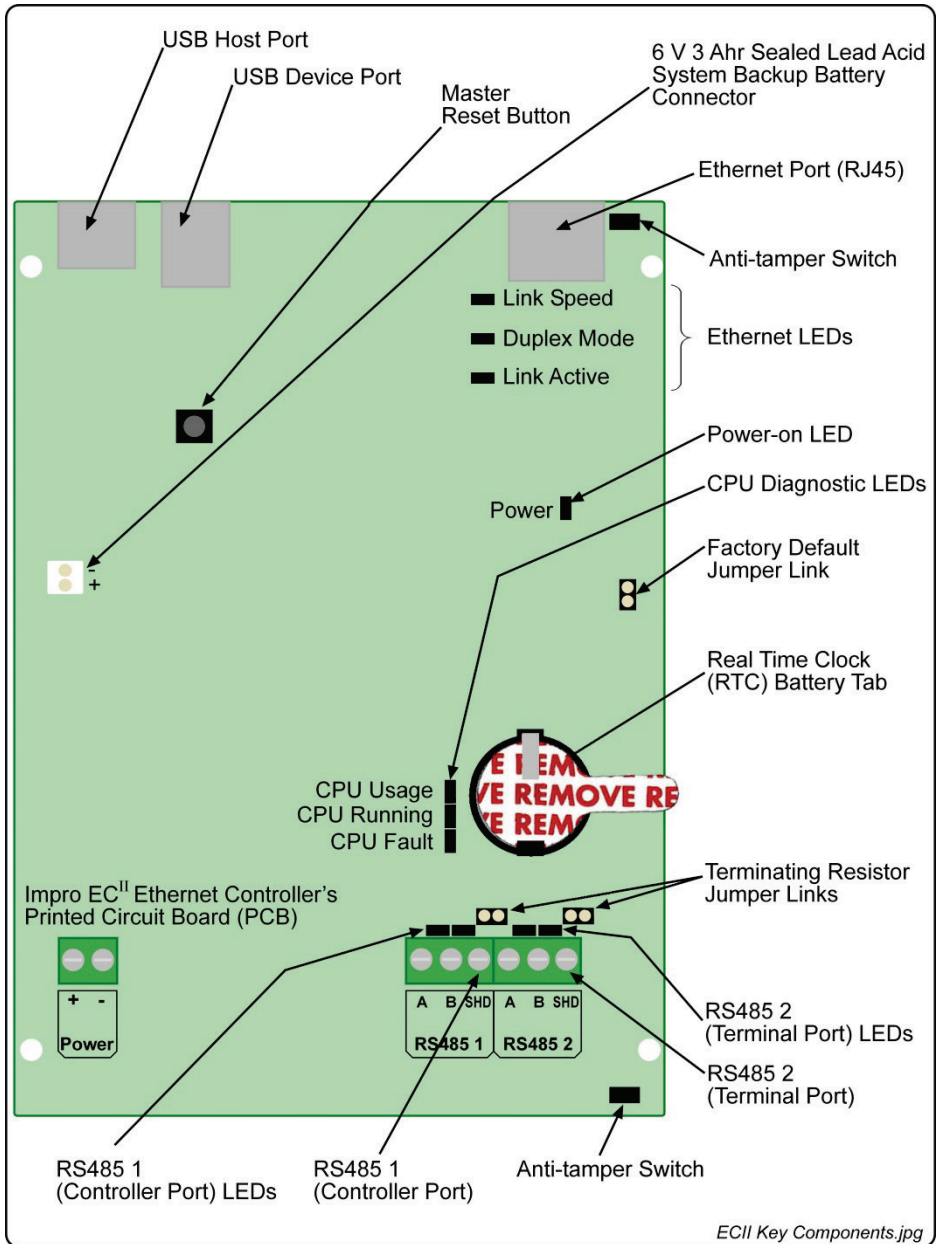
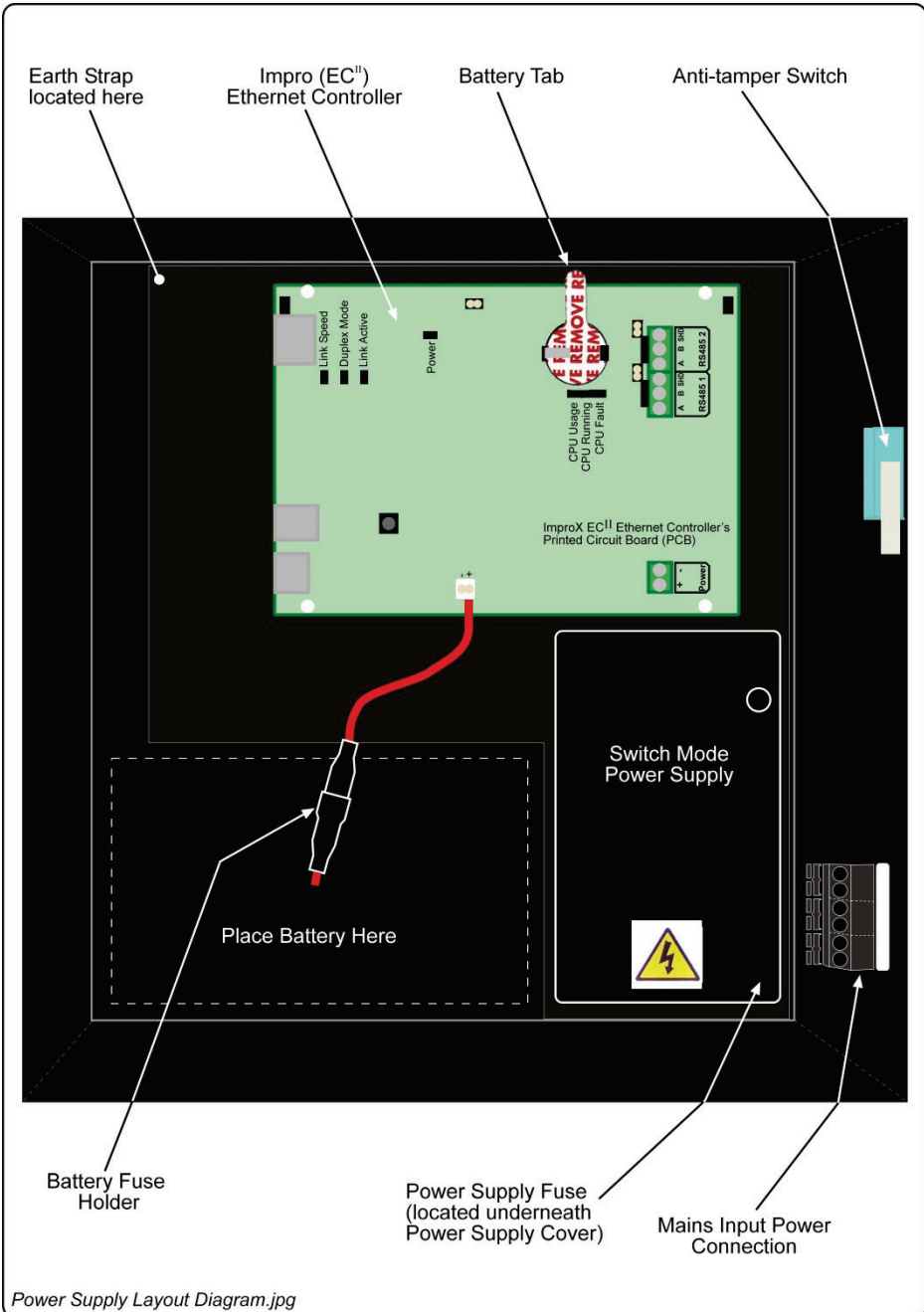

Figure 1: Key Component Positions



Power Supply Layout Diagram.jpg

Figure 2: Power Supply Combo (IPS970) Layout Diagram – Top View

Connecting the Impro EC^{II} Controller

Figure 3 shows the Controller's relationship with the rest of the Impro product range.

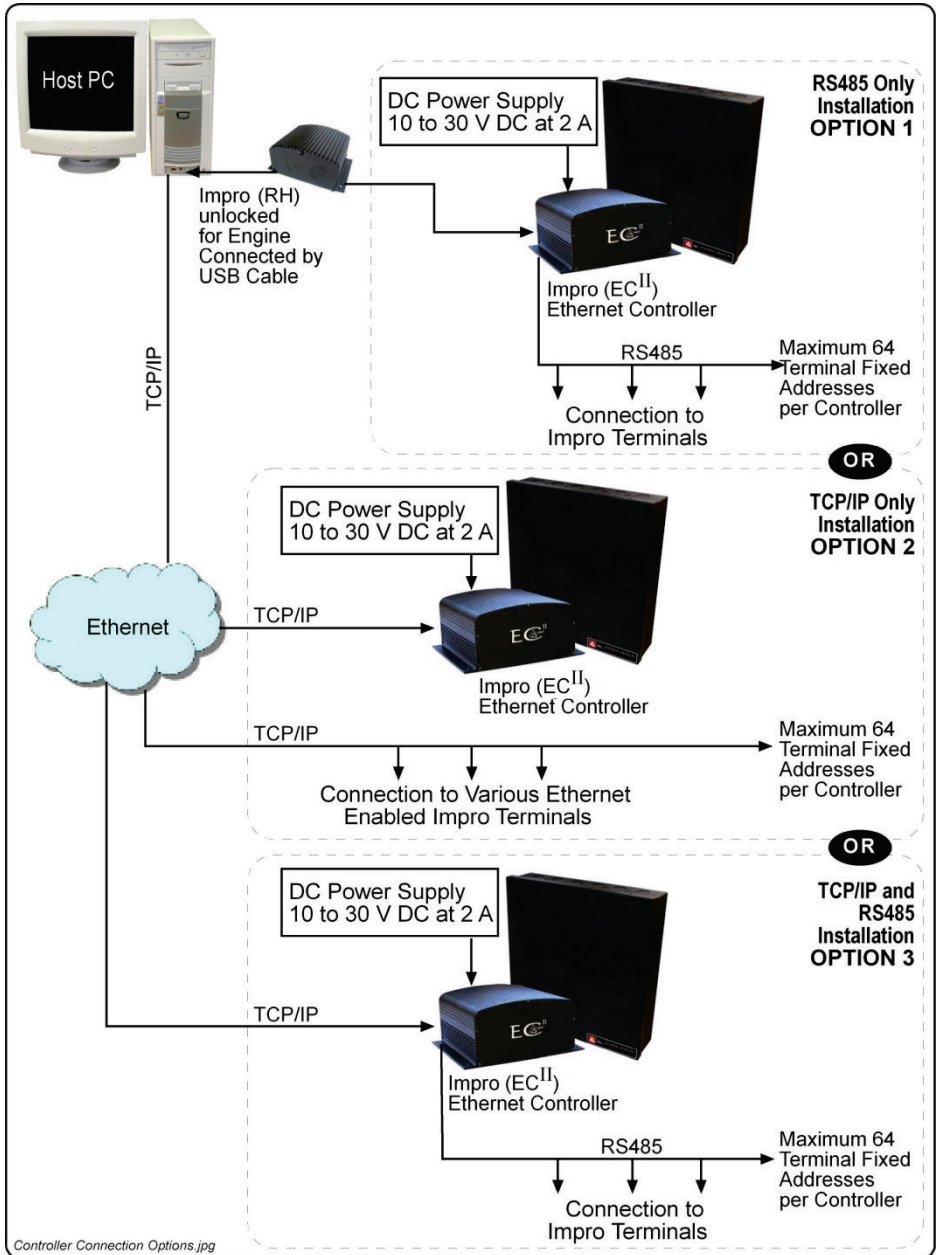

Figure 3: Controller Configuration Options

Figure 4 shows typical connection options for the Impro EC^{II} Controller.

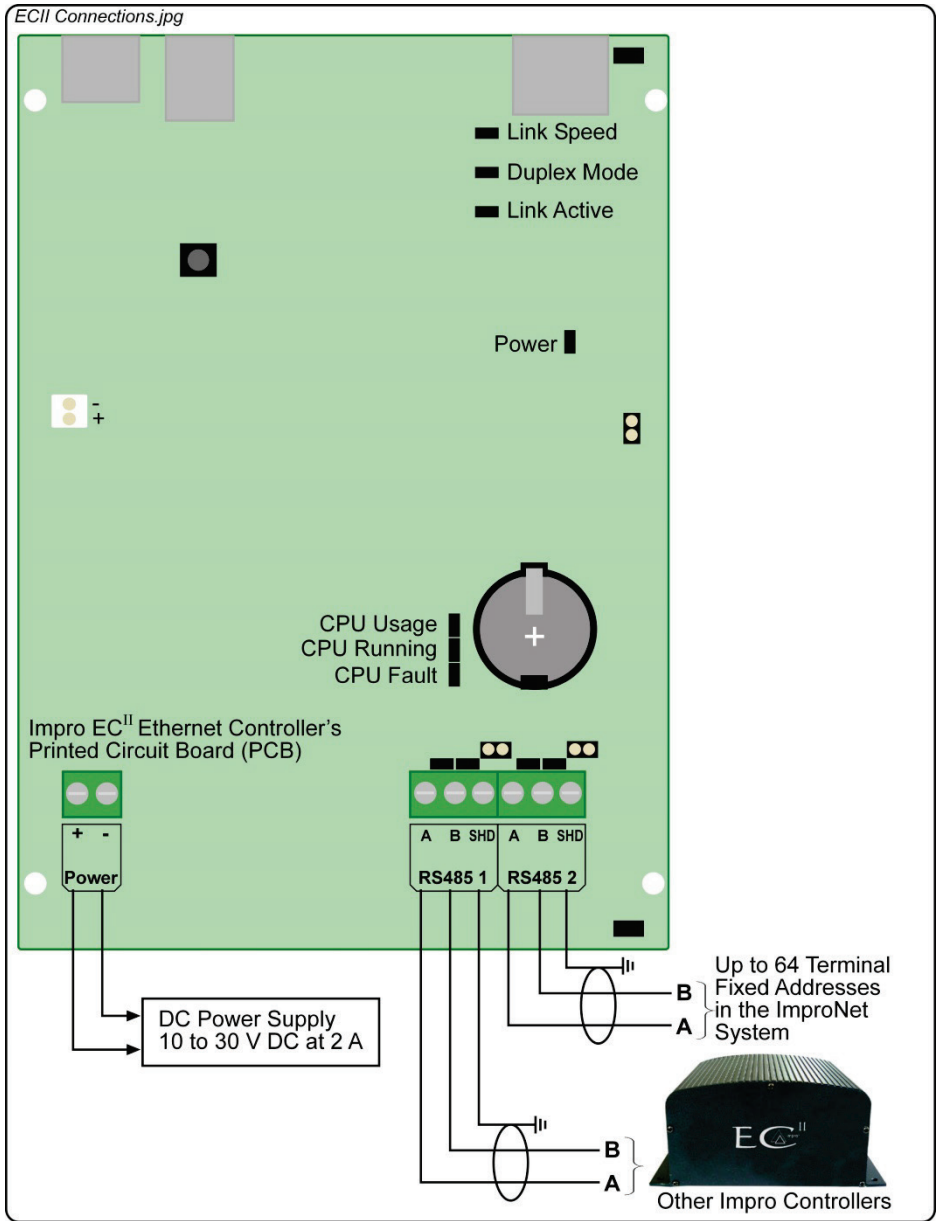

Figure 4: Typical Electrical Connections

NOTE: DO NOT connect (daisy chain) additional RS485 Controllers on Port 2, as the System will NOT Auto-ID these Controllers.

Settings Specific to the Power Supply Combo

WARNING: DO NOT REMOVE THE PLASTIC COVER PROTECTING THE SWITCH MODE POWER SUPPLY. REMOVING THE COVER PUTS YOU AT RISK OF ELECTRICAL SHOCK.

CAUTION: DO NOT exceed the Input Voltage specified.

Wiring the Mains Input Power Cord

WARNING: DO NOT TOUCH ANY PART OF THE CIRCUIT ONCE YOU'VE APPLIED POWER TO THE POWER SUPPLY COMBO.

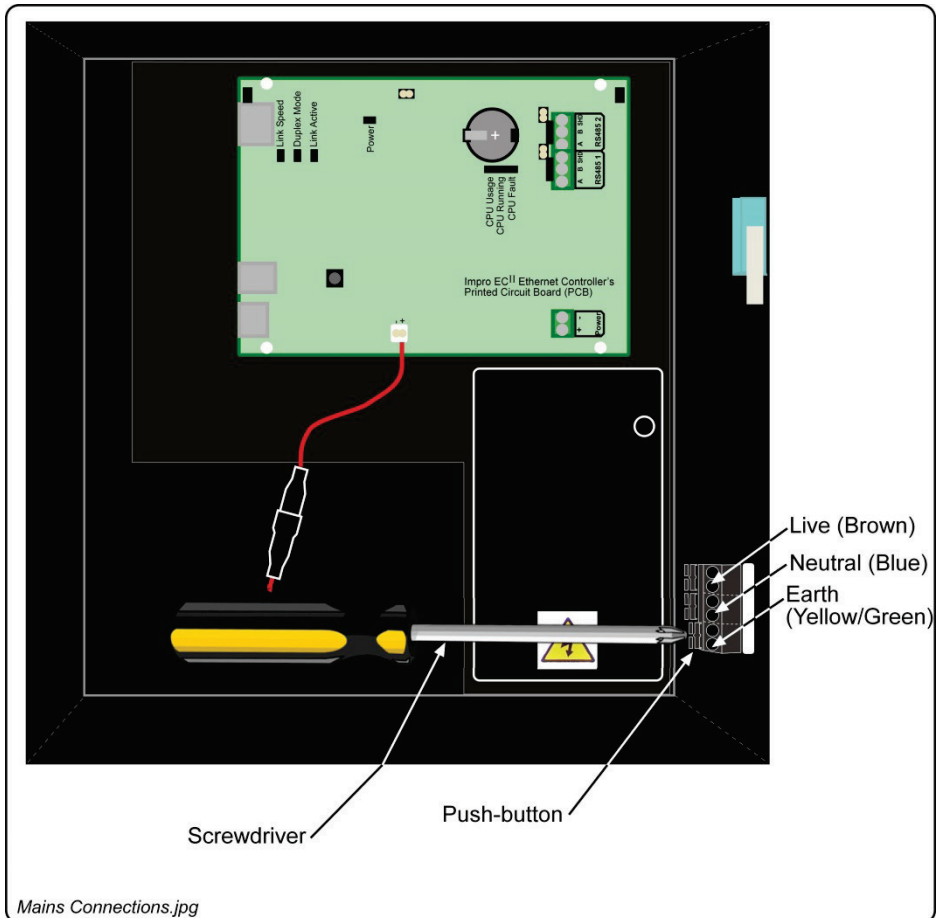

Figure 5: Mains Connections

Connect the Power Supply Combo to mains power as follows:

1. Open the Cabinet.
2. Using a suitable screwdriver, press and hold down the Push-button.

3. Insert the wire.
4. Release the Push-button.
5. Repeat steps 1 to 3 for each connection.
6. Attach a suitable Mains Input Power Plug using the following connections:
 - Live (Brown).
 - Neutral (Blue).
 - Earth (Yellow/Green).
7. Close the Cabinet.

Fuse Information

Fuse Type	Purpose	Rating
Battery Fuse	This fuse protects the Battery from overload as well as incorrect polarity connection.	3.15 A 250 V Slow-blow (5 mm x 20 mm).
Power Supply Fuse	This fuse protects the Power Supply from overload as well as incorrect polarity connection.	4 A 250 V Slow-blow (5 mm x 20 mm).

Table 1: Fuse Ratings

NOTE: Because of the delicacy of the replacement procedure, we recommend you contact your distributor before trying to replace the Power Supply Fuse.

Replacing the Battery Fuse

CAUTION: Ensure that you have disconnected the mains power supply to the Power Supply Combo, and removed the Positive Lead from the Battery before replacing the fuse.

1. Disconnect the mains power supply to the Power Supply Combo.
2. Open the Cabinet.
3. Disconnect the Positive Lead from the Battery.

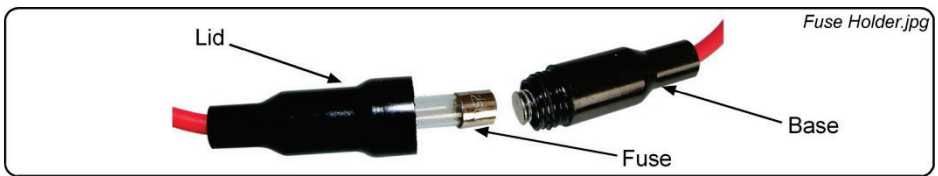

Figure 6: Fuse Holder

4. Unscrew the Fuse Holder's Lid from the Base.
5. Remove the old fuse.
6. Insert a new fuse into the longer end of the Fuse Holder.
7. Screw the Fuse Holder's Lid onto the Base.
8. Reconnect the Positive Lead to the Battery.
9. Close the Cabinet.
10. Reconnect the mains power supply to the Power Supply Combo.

Power Shut Down

The Impro EC^{II} Controller's 6 V 3 Ahr Sealed Lead Acid Backup Battery provides between 4-6 hours of uninterrupted power. Five minutes after the Battery Low signal's received by the Controller, the Controller switches to Hibernation Mode (low power). Hibernation Mode provides a further 48 hours of database (including transactions) memory retention.

Master Reset

The Impro EC^{II} Controller can be restarted manually, without removing the power connections, by pressing the Master Reset button (See Figure 1 for Key Component Positions).

Restoring Factory Default Settings

If you assign an invalid IP address to the Impro EC^{II} Controller, it will not be able to communicate. Restore the Controller's factory default settings as follows:

CAUTION: This will restore the firmware to the version set when shipped from the factory. If you have upgraded the Controller's firmware since installation, ensure that you upgrade again immediately.

1. With power applied to the Impro EC^{II} Controller, place a link across the pins of the Factory Default Jumper Link (LK4). (See Figure 1 for Key Component Positions).

NOTE: Take note of the Ethernet and CPU Diagnostic LEDs, the LEDs will switch OFF then ON signaling that restoration has taken place.

2. Remove the link.

Unit Address Information

Fixed Address Label

The last 8 digits of the MAC Address, that is 4A-9A-BC-3D (see Figure 7), translate to the products Fixed Address used by the System Software.

Attach the loose Fixed Address Label (packaged with the Controller) in position on the Unit Location Chart (or your sketched site plan).

MAC Address Label

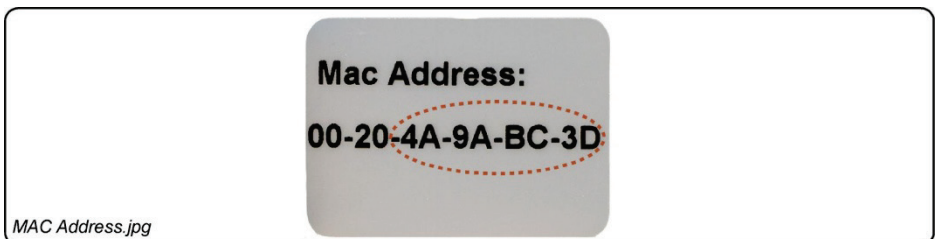

Figure 7: Sample MAC Address Label

Each Impro EC^{II} Controller is supplied with a separate MAC Address Label, much like the one shown in Figure 7, which uniquely identifies each Controller.





Attach the extra loose MAC Address Label, alongside the Fixed Address Label, to the Unit Location Chart enclosed (or your sketched site plan).



When the system installation is complete and all the units are represented on the Unit Location Chart (or your sketched site plan) by their Fixed Address and MAC Address Labels, file the document for future reference.

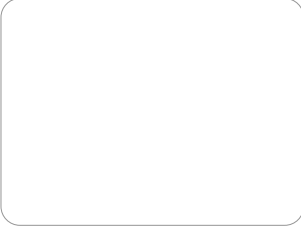

IP Address

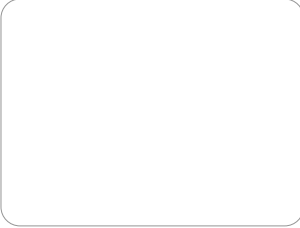
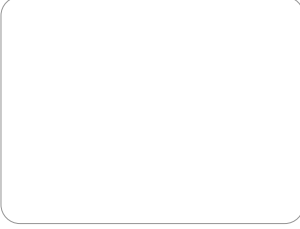
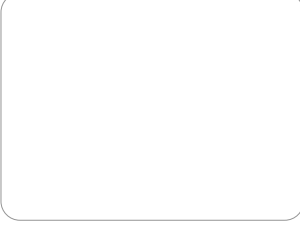

NOTE: All Impro EC^{II} Controllers have the same IP Address (192.168.100.1). In the absence of a DHCP server, plug each Controller into the network individually and set the static IP Address.

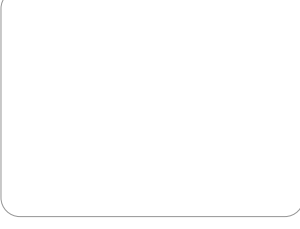

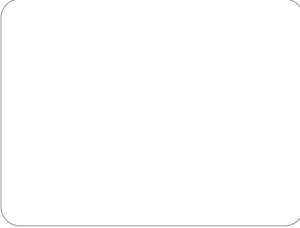
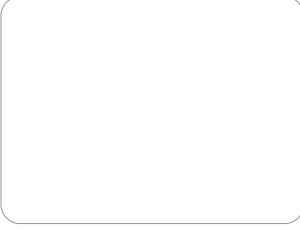
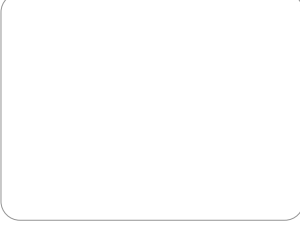
Unit Location Chart

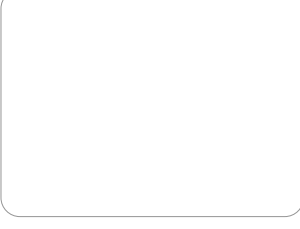

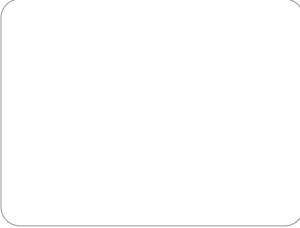
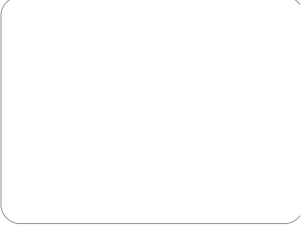
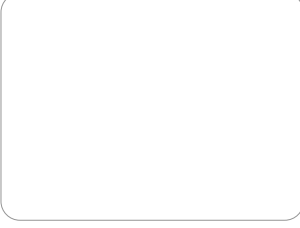
Fixed Address Label	Unique Location Description
	
	
	
	

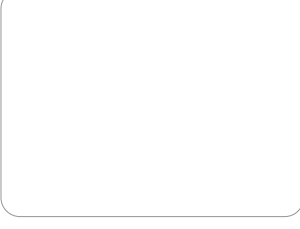

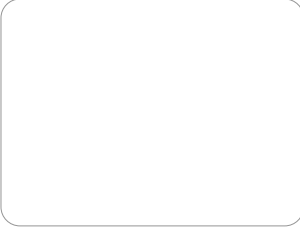
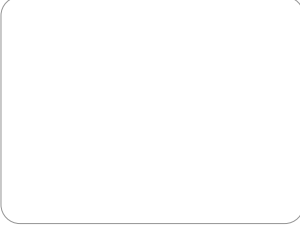
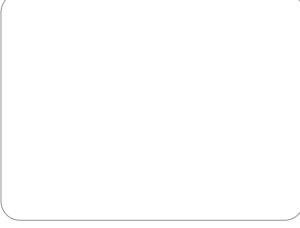
Fixed Address Label	Unique Location Description
	
	
	
	
	

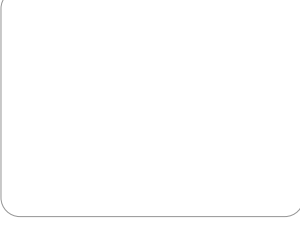

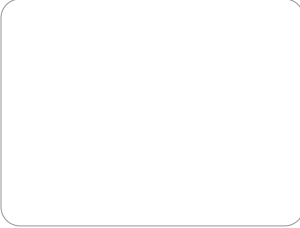
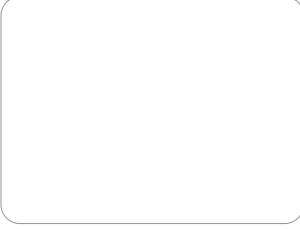
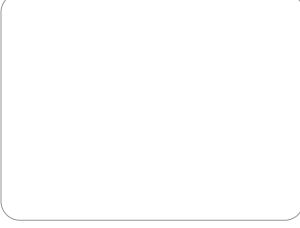
Fixed Address Label	Unique Location Description
	
	
	
	
	

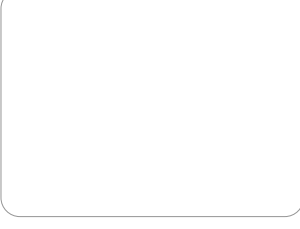
Fixed Address Label	Unique Location Description
	
	
	
	
	

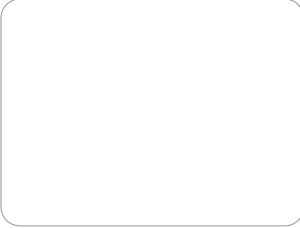
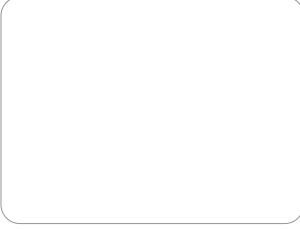
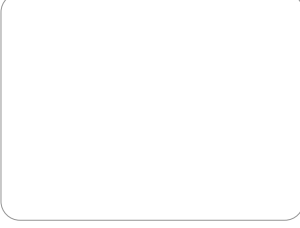
Fixed Address Label	Unique Location Description
	
	
	
	
	

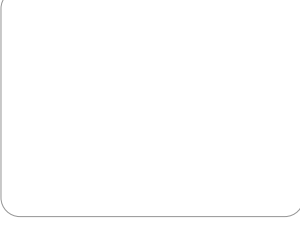
Fixed Address Label	Unique Location Description
	
	
	
	
	

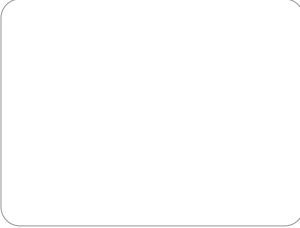
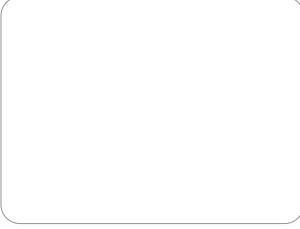
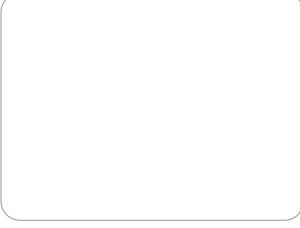
Fixed Address Label	Unique Location Description
	
	
	
	
	

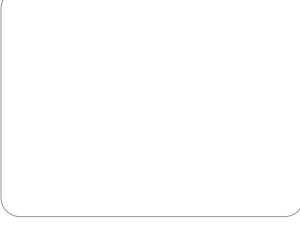
Fixed Address Label	Unique Location Description
	
	
	
	
	

Fixed Address Label	Unique Location Description
	

Table 2: Unit Location Chart

GUARANTEE OR WARRANTY

This product conforms to our Guarantee or Warranty details placed on our Web Site, to read further please go to www.impro.net.

USER NOTES

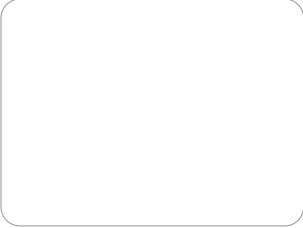

This manual is applicable to the Impro (EC^{II}) Ethernet Controller,
XEC900-0-0-GB-06 and IPS970-0-0-GB-05.

(The last two digits of the Impro stock code indicate the issue status of the product).

XEC300-0-0-GB-09	Issue 10	Sept 2015	Impro ECII\English Manuals\LATEST ISSUE\ XECII-in-sm-en-10.docx
------------------	----------	--------------	--