



# IMPROX REGISTRATION INTERFACE

## ImproX (RS) Registration Interface INSTALLATION MANUAL

### SPECIFICATIONS

<b>Working Environment</b> .....	The ImproX RS is designed to work in an indoor (dry) environment similar to IP20. The ImproX RS is, therefore, NOT sealed against water.	
<b>Scanner Operation</b> .....	125 kHz.	
<b>Input Voltage</b> .....	5 V DC Supplied from the USB Port.	
<b>Power Requirements</b>	<b>Current (mA)</b>	<b>Power (W)</b>
Maximum Current Drawn from the USB Port .....	200	1.0
<b>Third-party Port</b> .....	5 V DC $\pm$ 0.1 V is supplied to power the single Reader connected to this Port. A maximum of 100 mA can be supplied from this Port.	

### Installer Interfaces

Registration Interface	
Power Indicator	
Power LED .....	Blue (steady) (externally visible).
Diagnostic Indicators	
USB Tx LED.....	Red (flashing) (internally visible).
USB Rx LED .....	Green (flashing) (internally visible).
RS485 Tx LED .....	Red (flashing) (internally visible).
RS485 Rx LED.....	Green (flashing) (internally visible).
ImproX RRA or RRM	
Status Indicator	
Status LED.....	Bi-colour, Red or Green LED.
Buzzer	
Volume and Tone .....	Four volume, single tone (Software dependent).

# INSTALLATION INFORMATION

## Accessories

Find the following when unpacking the Registration Interface:

- An ImproX (RS) Registration Interface housed in a Black, Aluminium extruded Cabinet. The Cabinet consists of a Top Cover, a Base and two End Plates (each End Plate is attached with three Thread Cutter Screws (M3 x 8 mm)).
- A 1.8 m (5.90 ft) standard USB Cable with a Type A to Type B Connector.
- An extra Fixed Address Label.

## General

Remember the following when installing the Registration Interface:

### Communications Distance

- The USB communications distance between the Host PC and the Registration Interface **MUST NOT** exceed 5 m (16.40 ft).
- **DO NOT** cut and join the supplied USB Cable. If extension of the USB Cable is required, source a new longer length USB Cable.

### Distance between the Registration Interface and the ImproX RRM or ImproX RRA

The maximum cable distance between the ImproX Registration Interface and the ImproX RRM or ImproX RRA, **MUST NOT** exceed 2 m (6.56 ft).

## Mounting the Cabinet

**CAUTION:** Make certain that you mount the ImproX RS on a vibration-free surface.



Select the mounting position of the ImproX RS, considering accessibility, routing of wires and visibility of the externally visible LED.





Secure the Cabinet to the mounting surface, using four suitable screws and wall plugs, nuts and bolts or rivets.

## DIP-switch Settings

The format selection for each type of device that can be connected to the Third-party Port is made by setting the internal DIP-switches as indicated in Table 1.

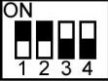
*NOTE: Terminals 'A' and 'B' in Table 1 are on the Third-party Port Terminal Block.*

DIP-switch Position	Format	Connections
0  DIP-switch 0 shows all the switches in the OFF position	No peripheral Reader	N/A
1  DIP-switch 1 shows switches 2, 3 and 4 in the OFF position	Mifare Remote (ImproX RRM)	Rx to terminal 'A' Tx to terminal 'B'

DIP-switch Position	Format	Connections
2 	RF Receiver	Data Line to terminal 'B'
3 	Magstripe ABA Track 2	Data Line to terminal 'A' Clock Line to terminal 'B'
4 	Barcode Code-39 with Checksum	Data Line to terminal 'B'
5 	Barcode Code-39 without Checksum	Data Line to terminal 'B'
6 	Wiegand 26/37/40 and 44	0 Data Line to terminal 'B' 1 Data Line to terminal 'A'
7 	Wiegand Open Format	0 Data Line to terminal 'B' 1 Data Line to terminal 'A'

**Table 1: DIP-switch Settings**

**NOTE:** *Once the DIP-switch setting is modified reset the ImproX RS to acknowledge the new settings.*

Blank Space

# CONNECTING THE REGISTRATION INTERFACE

Figure 1 shows a detailed connection diagram for the ImproX RS.

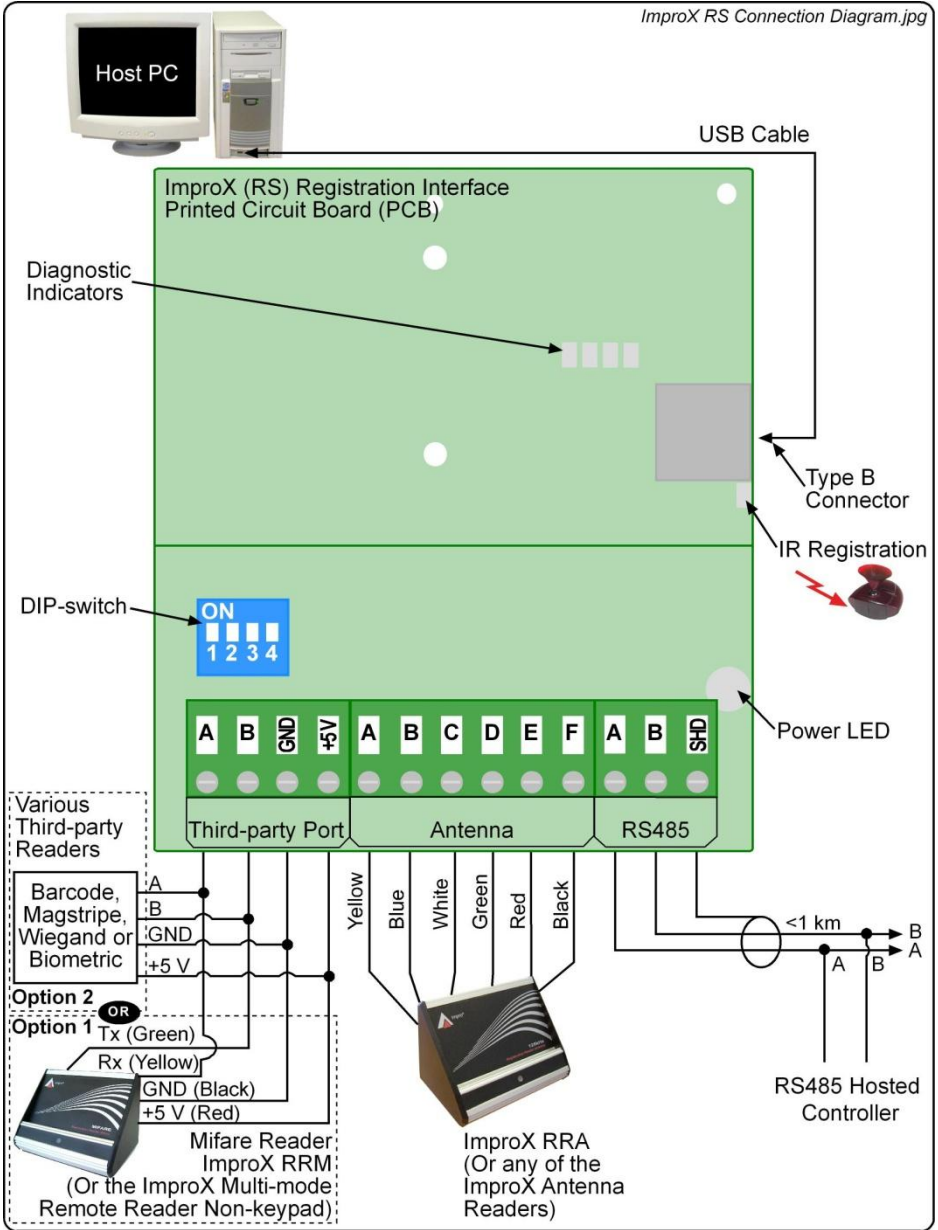

**Figure 1: Typical ImproX RS Electrical Connections**

## **Power-on Self-test**

---

The Power-on Self-test tests the RAM and Flash Checksums.

If any parameter in the Self-test fails, the Registration Reader (i.e. ImproX RRA or ImproX RRM) emits a continuous beep for 2 seconds.

When the Registration Interface passes the Self-test, the Registration Reader (i.e. ImproX RRA or ImproX RRM) emits two short beeps, each 200 ms in duration, separated by a 200 ms inter-beep pause.

## **Testing the Connection**

When you connect the Registration Interface to the PC for the first time, the PC will prompt you to install the necessary Drivers, once installed, the Power LED will illuminate Blue (steady).

This confirms the Registration Interfaces connection is correct and working.

Further connections on the same PC will not call for reloading the Drivers.

## **Fixed Address Label**

---

Keep the Fixed Address Label in a safe place, as you may need the Label at a later date if you wish to upgrade your Software.

## **GUARANTEE OR WARRANTY**

This product conforms to our Guarantee or Warranty details placed on our Web Site, to read further please go to [www.impro.net](http://www.impro.net).

## **USER NOTES**

## USER NOTES

## USER NOTES



This manual is applicable to the ImproX (RS) Registration Interface,  
XRS902-1-0-GB-01.

(The last two digits of the Impro stock code indicate the issue status of the product).

XRS305-0-0-GB-08	Issue 09	Sep 2010	ImproX RS\English Manuals\LATEST ISSUE\ ImprX RS-inism-en-09.docx
------------------	----------	-------------	--